

# Oticon | ConnectLine

INSTRUCTIONS FOR USE

TV 2.0



**oticon**  
PEOPLE FIRST

## Thank you

Thank you for choosing our product as your means to better hearing.

To support your efforts, we have put great care and attention into making sure that your new TV adapter has the highest quality and is easy to use.

The complete system description is documented online at [www.oticon.com/tv](http://www.oticon.com/tv)

Here you will also find interactive presentations, "how to" videos and a support section with frequently asked questions.

We recommend that you read this manual carefully to achieve the maximum benefit of your new TV adapter, before you start to use it. If you have any questions about the use of the TV adapter, please contact your Hearing Care Professional.

Manufactured under license from Dolby Laboratories.

Dolby and the double-D symbol are registered trademarks of Dolby Laboratories.

## Indications for Use

The TV adapter is intended to be used together with the Oticon Streamer or Oticon Streamer Pro and Oticon wireless hearing instruments.

This enables the hearing instrument user to listen to the TV, by wirelessly sending the TV sound from the TV adapter through the Streamer direct to the hearing instruments.

## **IMPORTANT NOTICE**

Please familiarise yourself with the entire content of this booklet before using your TV adapter. It contains instructions and important information about the use and handling of your TV adapter.

## Contents

Package content	7
TV adapter overview	8
Warnings	10
Installation	13
Placing the TV adapter	14
Connecting the TV adapter to a power outlet	16
Connecting the TV adapter to the TV	18
Connecting using TOSLINK	20
Connecting using RCA	22
Connecting using mini jack adapter	24
Connecting using SCART	26
Pairing the Streamer to the TV adapter	28
Turn on the TV sound	34
Turn off the TV sound	34
SelectMe, using more than one TV adapter	36
Technical information	38



# Package content

The TV adaptor box consists of the following elements:



TV adapter



Power supply



TOSLINK



RCA cable



This guide (Installation guide and Instructions for use)

















SCART adapter



Mini jack adapter

## TV adapter overview

Mode	Power indicator	TV indicator
Power on, no connection to the Streamer		
In pairing mode		
Streaming - no audio input detected		
RCA inserted and streaming		
TOSLINK inserted and streaming (digital)		
TOSLINK inserted and streaming (invalid signal)*		
Fault condition **		

○ No light   ◐ Blinking   ● Steady

\* Try other input connection

\*\* Contact your Hearing Care Professional



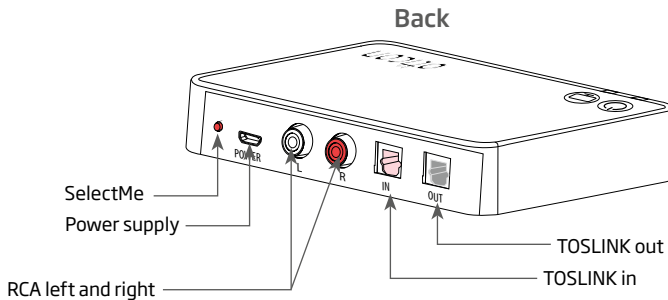
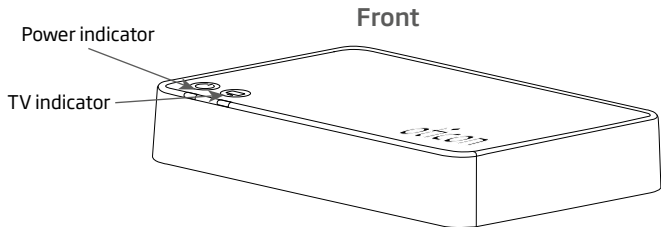

For more information please refer to: [www.oticon.com/TV](http://www.oticon.com/TV)

## **Warnings**

You should familiarise yourself fully with the following general warnings and the entire contents of this booklet before using your TV adapter.

### **Products to be connected to external equipment**

- The safety of the use of the TV with RCA input cable is determined by external signal source. When the input cable is connected to mains-operated equipment, this equipment must comply with IEC-60065, IEC-60601 or equivalent safety standards.
- The TV adapter is designed to comply with the most stringent Standards of International Electromagnetic Compatibility. However, the TV adapter might cause interference with other medical devices. Please contact relevant personnel to obtain permission before using the TV adapter in hospitals or similar venues.

## Warnings

- The TV adapter is not a toy and therefore should be kept out of the reach of children and anyone else who might swallow parts or otherwise cause injury to themselves. Special attention should be paid to the smaller components in order to prevent children from swallowing them and choking.

*If a part is swallowed, see a doctor immediately.*

The TV adapter must never be washed or immersed in water or other liquids.



# Installation

## Activating the TV adapter for the first time

Before you can use the Streamer and your hearing aids with your TV, the TV adapter must be connected to a power outlet, connected to the TV and paired with your Streamer.

This is a step-by-step guide on how to install the TV adapter.

All needed parts for the installation are included in the package.

## Placing the TV adapter

There are two options of placing the TV adapter:

1. Close to the TV - placed horizontally (A).
2. Behind or close to the TV hanging on the wall (vertically) (screws not included) (B).

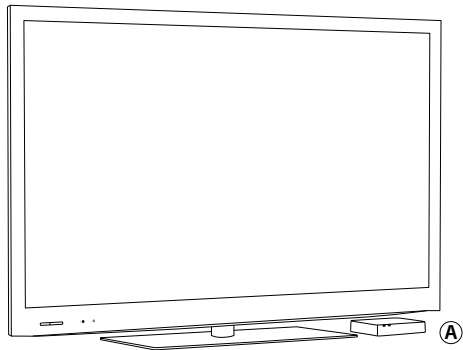

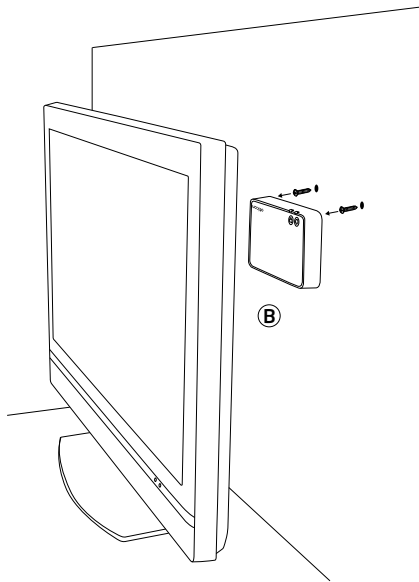

## Connecting the TV adapter to a power outlet

Start by connecting the TV adapter to a power outlet.

### Use the power supply from box 1

1. Plug the power cord into the “power” connector on the TV adapter (A).
2. Plug the power supply into the mains wall socket (B).
3. Check that the power is turned on, after a few seconds the power indicator  will light green on the front of the TV adapter (C).



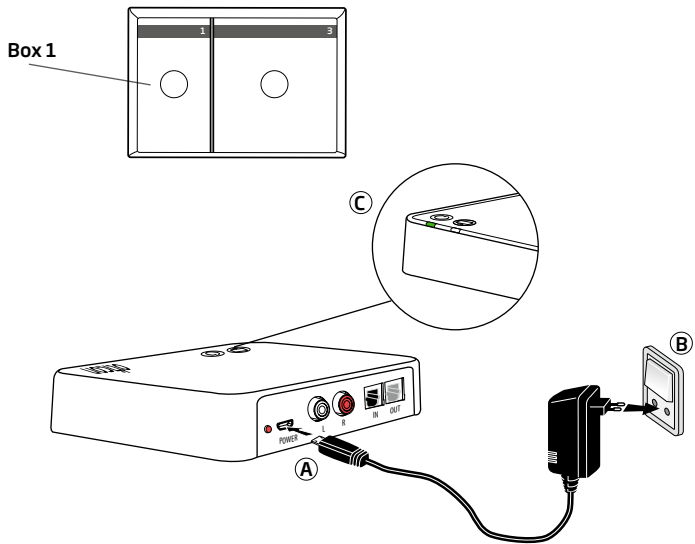

## Connecting the TV adapter to the TV

You can connect the TV adapter to the TV in four different ways.

Connection	Page
TOSLINK. Either digital stereo (PCM) or Dolby® Digital *	20
RCA audio output L+R	22
Mini jack audio output (typically headphone output)	24
SCART audio output (L+R)	26

\*Dolby and the double-D symbol are registered trademarks of Dolby Laboratories.

Please refer to the detailed specification of ConnectLine TV 2.0. ([www.oticon.com/tv](http://www.oticon.com/tv)) and your TV manual/specifications to ensure compatibility.

Please see the following pages for a solution which fits your TV.

TOSLINK (p. 20)

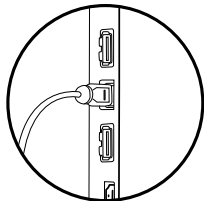

RCA (p. 22)

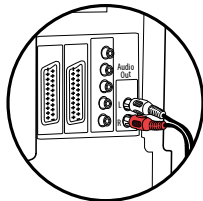

Mini jack (p. 24)

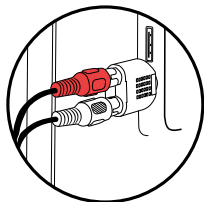

SCART (p. 26)

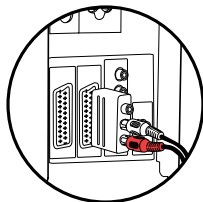

For more information please refer to: [www.oticon.com/TV](http://www.oticon.com/TV)

## Connecting using TOSLINK

1. Use the TOSLINK cable from box no. 3 (A).
2. Remove the plastic cap from the TOSLINK cable. (B)
3. Connect the TOSLINK cable to the TOSLINK output on your TV/home theatre system (C).
4. Connect the TOSLINK cable to the pink TOSLINK input (D) on the TV adapter.
5. The TOSLINK output (E) may be used to connect other TOSLINK devices such as external Dolby Decoders and surround sound systems etc.
6. Refer to page 28 for pairing of TV adapter with your Streamer.

*Please note: It may be necessary to configure your TV, DVD player or home theatre system so that the correct audio output is available on the TOSLINK output.*

*For more advanced or complex installations please refer to the support section on [www.oticon.com/tv](http://www.oticon.com/tv)*

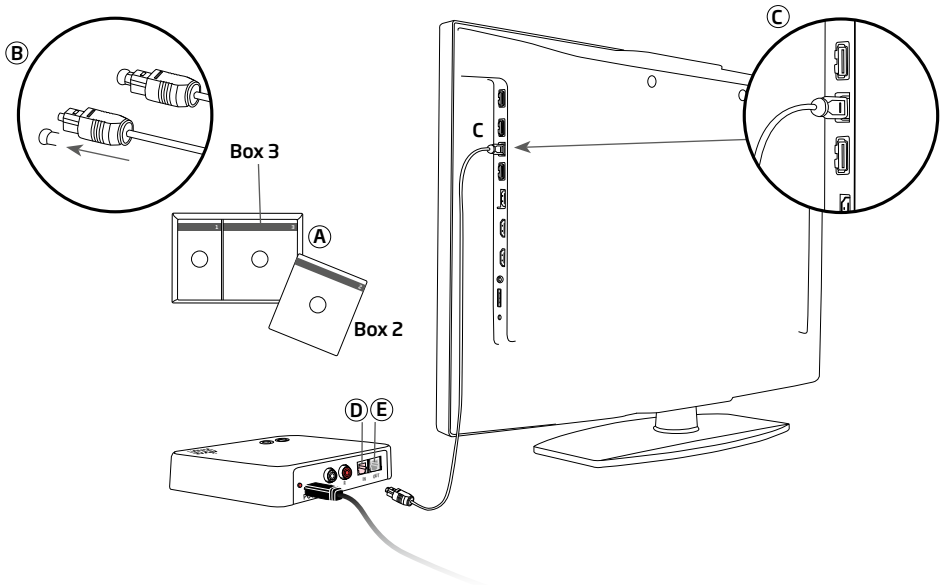

## Connecting using RCA

1. Use the RCA cable from box no. 2 (A).
2. Connect the RCA cable to the RCA **output** on your TV (B) or home theatre system.  
(Typically marked "L - R AUDIO OUT" and found on the TV back or bottom panel.)
3. Connect the RCA cable to the RCA connectors (C) on the back of the TV adapter.
4. Refer to page 28 for pairing of Streamer with the TV adapter.

*Please note: It may be necessary to configure your TV so that the correct audio output is available on the RCA output.*

*For more advanced or complex installations please refer to the support section on [www.oticon.com/tv](http://www.oticon.com/tv)*

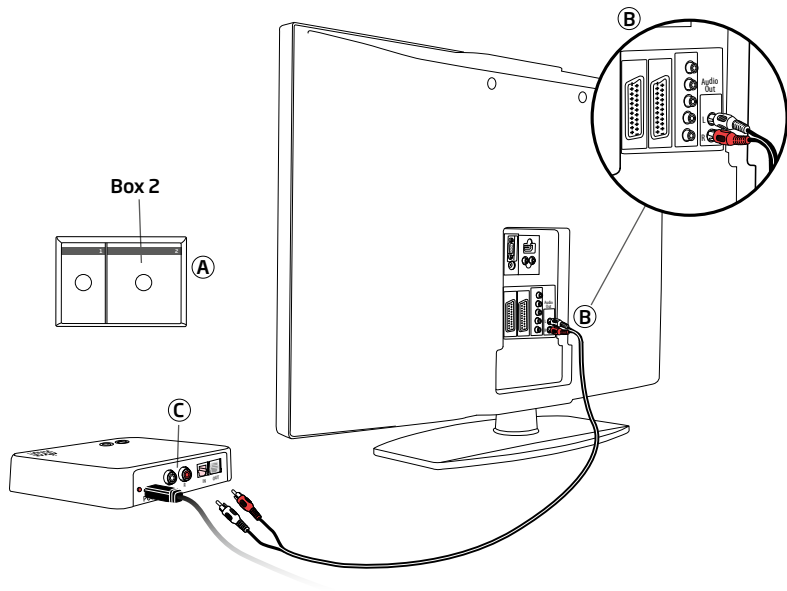

## Connecting using mini jack adapter

1. Use the mini jack adapter from box no. 2 (A).
2. Connect the RCA cable to the mini jack adapter (B1).
3. Connect the mini jack to the TV, this is typically the headphone output (B2).
4. Connect the RCA connectors to the TV adapter RCA input (C).
5. Refer to page 28 for pairing of the TV adapter with Streamer.

*Please note: The TV speakers may be muted when connecting to the headphone output, and sound only heard through the Streamer/TV adapter.*

*For more advanced or complex installations please refer to the support section on [www.oticon.com/tv](http://www.oticon.com/tv)*



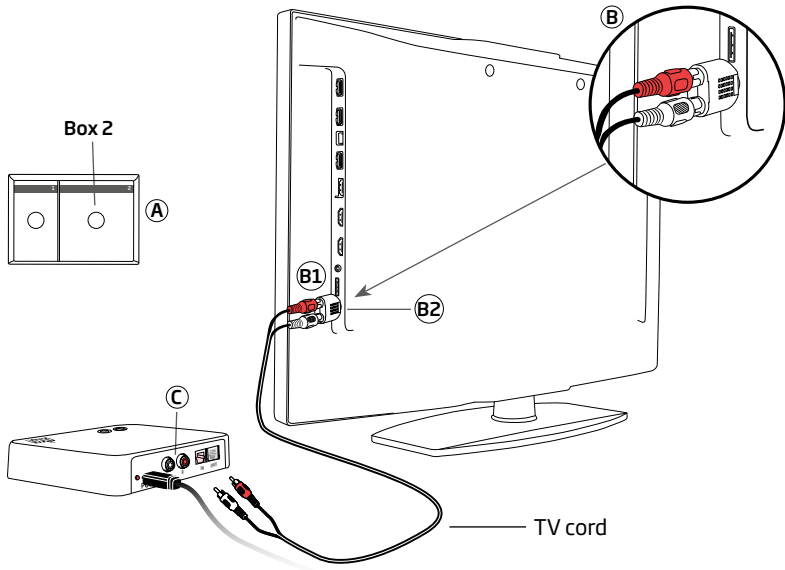

## Connecting using SCART

1. Use the SCART adapter from box no. 2 (A).
2. Connect the RCA cable to the red and white terminals on the SCART adapter (B).
3. Connect the SCART adapter to the SCART **output** on your TV (C).
4. Connect the RCA connectors to the TV adapter RCA input (D).
5. Refer to page 28 for pairing of TV adapter with Streamer.

*Please note: The audio output on the SCART connector can be dependent on the source selected on the TV. For example some TV's will only make TV sound available on the SCART output (i.e. not e.g. sound from a connected DVD player).*

*For more advanced or complex installations please refer to the support section on [www.oticon.com/tv](http://www.oticon.com/tv)*

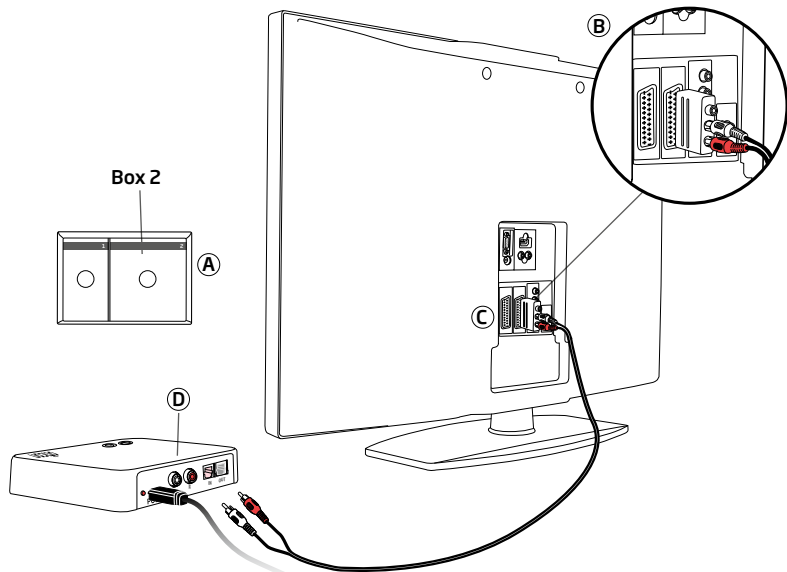

## Pairing the Streamer to the TV adapter

Before using your Streamer for TV listening, it must be paired to the TV adapter.

For pairing:

1. Make sure the TV adapter is powered on, i.e. the power indicator is steady green.
2. Press and hold the on/off button on the Streamer Pro (B) for 5-6 seconds (A) until the blue light starts blinking.
3. Place the Streamer on top of, or close to, the TV adapter - the pairing takes around 20-60 seconds. The TV adapter will automatically begin pairing.
4. The pairing is completed when the power indicator on the TV adapter and the on/off button on the Streamer briefly turns steady blue, followed by orange status.
5. Pairing is done only once and will normally not have to be repeated.

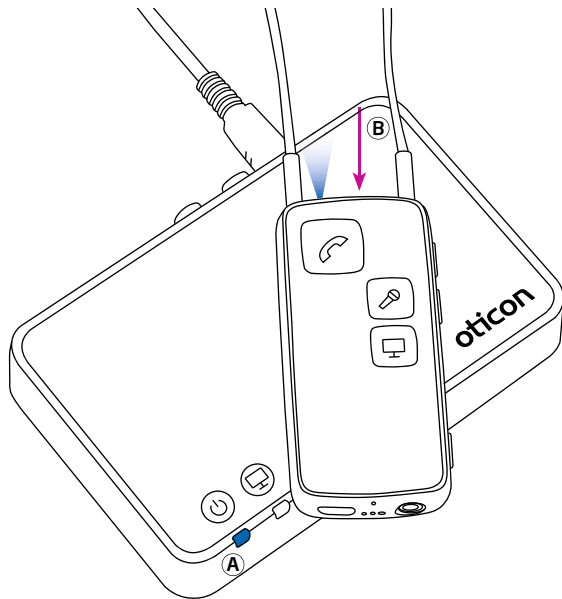

Pairing			
Streamer Pro top status	Streamer Pro front	TV adapter	Description
			Streamer and TV adapter on
			Streamer in pairing mode
			Pairing complete
			Streaming - no audio input detected
			RCA inserted and streaming
			TOSLINK inserted and streaming (digital)

Steady Blinking



## **Volume control**

Use the volume button on the Streamer to adjust the TV volume level in the hearing instruments. Adjust the volume by pressing up or down briefly. Repeat the brief press for further adjustments.

### **MUTE**

While watching TV it is possible to switch off the microphones in your hearing instruments, so that only the sound from the TV is heard.

Press both the up and down volume buttons until the surrounding sound is muted. You will hear a confirmation beep indicating that the microphones in the hearing instruments are now muted.

*Notice: The TV volume in the hearing instruments is normally not affected by the volume adjustments from the TV remote control.*



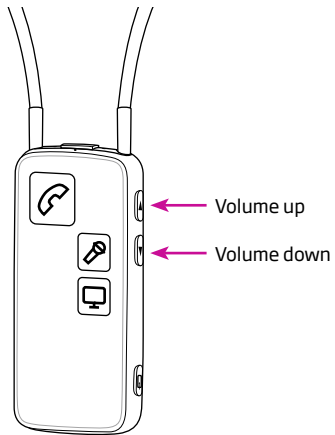

Streamer Pro

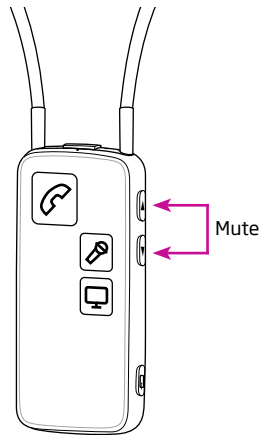

Streamer Pro

## Start TV listening

Make sure to wear the Streamer around your neck using the neck loop, and make sure the Streamer is powered on.

## Turn on the TV sound

Briefly press the TV button on the front of the Streamer. The Streamer connects to the TV adapter. After a few seconds a steady orange light is shown on the Streamer and the TV adapter. You will hear a confirmation beep in your hearing instruments followed by the sound from the connected TV.

## Turn off the TV sound

Briefly press the TV button on the front of the Streamer. The orange lights turn off on both the Streamer and the TV adapter. You will hear a confirmation beep in your hearing instruments.

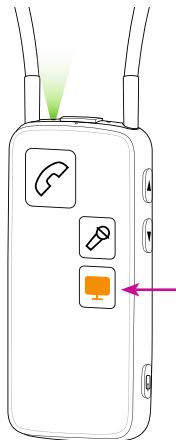

Pairing			
Streamer Pro top status	Streamer Pro front	TV adapter	Description
			Streamer and TV adapter on
			Streaming - no audio input detected
			RCA inserted and streaming
			TOSLINK inserted and streaming (digital)

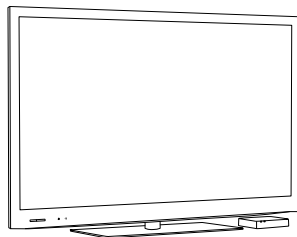

## SelectMe, using more than one TV adapter

With Streamer Pro 1.1 and later you can use multiple TV adapters. E.g. one in the living room and one in the bedroom.

To switch between TV adapters:

1. Make sure you are not connected to any TV adapter i.e. the Streamer should be turned on, but not active.
2. Briefly press the SelectMe button on the TV adapter you wish to hear the sound from (A).
3. The TV adapter is automatically connected. You will hear a confirmation beep in your hearing instruments followed by the sound from the connected TV.

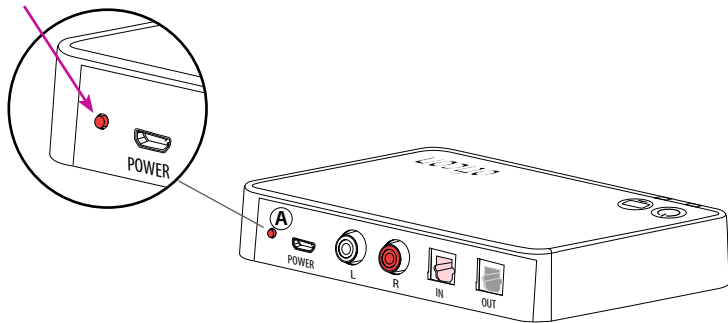

## Technical information

The TV Adaptor contains a 2.4 GHz Transmitter. The emission power from the TV adapter is max. 37 dB $\mu$ V/m @ 3 meters and is well below international emission limits for Human Exposure.

This instrument contains a module with:

FCC ID: U28TVBOX03

IC: 1350B-TVBOX03

The device complies with Part 15 of the FCC rules and RSS-210 of Industry Canada.

### **Operation is subject to the following two conditions:**

1. This device may not cause harmful interference.
2. This device must accept any interference received, including interference that may cause undesired operation.

IC radiation exposure statement: This equipment complies with IC radiation exposure limits set forth for an uncontrolled environment. End users must follow the specific operating instructions for satisfying RF exposure compliance.

This transmitter must not be co-located or operating in conjunction with any other antenna or transmitter.

Changes or modifications not expressly approved by the party responsible for compliance could void the user's authority to operate the equipment. To comply with FCC RF exposure requirements, the device and the antenna for this device must be installed to ensure a minimum separation distance of 20 cm or more from a person's body. Other operating configurations should be avoided.

NOTE: This equipment has been tested and found to comply with the limits for a Class B digital device, pursuant to Part 15 of the FCC rules. These limits are designed to provide reasonable protection against harmful interference in a residential installation. This equipment can radiate radio frequency energy and, if not installed and used in accordance with the instructions, may cause harmful interference to radio communications. However, there is no guarantee that interference will not occur in a particular installation.

If this equipment does cause harmful interference to radio or television reception, which can be determined by turning the equipment off and on, the user is encouraged to try to correct the interference by one or more of the following measures:

- Relocate the receiving antenna.
- Increase the distance between the equipment and receiver.
- Connect the equipment into an outlet on a circuit different from that to which the receiver is connected.
- Consult the manufacturer or an experienced radio/TV technician for help.



Hereby, Oticon A/S declares that this TV adapter is in compliance with the essential requirements and other relevant provisions of Directive 1999/5/EC.

Declaration of conformity is available at:

Oticon A/S  
Kongebakken 9  
DK-2765 Smørum  
Denmark  
[www.oticon.com](http://www.oticon.com)

**CE 1177**



Waste from electronic  
equipment must be  
handled according to  
local regulations.



NII75





## People First

People First is our promise  
to empower people  
to communicate freely,  
interact naturally and  
participate actively



0000123570000001

**oticon**  
PEOPLE FIRST